

- 0 — Block with common check valve  
 2 — Standart çek valfli blok  
 Z80 — Number of spools  
 R — Sürgü sayısı  
 Directional control valve type — Yön kontrol valfi tipi  
 Inlet high pressure – right — Giriş yüksek basıncı - sağ  
 A — First spool distribution type — ilk mil dağıtım tipi  
 1 — Spool control / detend and etc. — Sürgü kontrolü / dedant vs.  
 A — Second spool distribution type — ikinci sürgü dağıtım tipi  
 1 — Spool control / detend and etc. — Mil kontrolü / dedant vs.  
 G — Ports / Threads — Girişler / Diş tipi  
 KZ1 — General operation feature — Genel çalışma özelliği  
 T — With “teton” — “Meme başlı”  
 P — Operation feature – pneumatic — Pnömatik kontrol özelliği  
 E — With electric switch — Elektrik düğmeli  
 C2 — High pressure carry over — Yüksek basınç ayırıcı  
 11 — Connection ports in use — Kullanılan bağlantı girişleri

Table / Tablo 1

Type / Tip	A	B	C	D	P1	P2	T1	T2
01Z80	67	80	122	65	+	+	-	-
02Z80	67	80	160	103	+	+	+	+
03Z80	67	80	198	141	+	+	+	+
04Z80	67	80	236	179	+	+	+	+
05Z80	67	80	274	217	+	+	+	+
06Z80	67	80	312	255	+	+	+	+

Table / Tablo 2

Spool control / Sürgü kontrolü	E
1, 4, 5, 6, 7, 8, 9, 10, 11	40
2, 3, 12, 14	72
13	44

Way of distribution / Dağıtım yolu – Parallel / Paralel

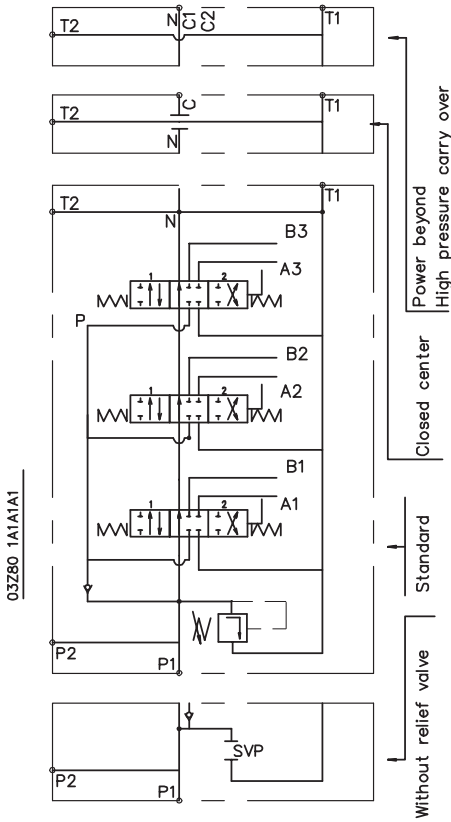
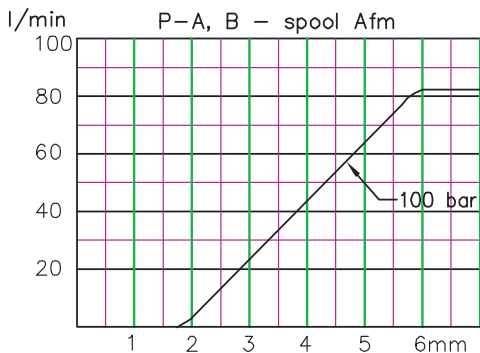
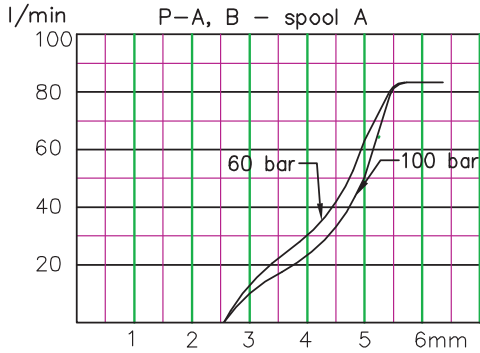

**Table / Tablo 3**

Code / Kod	Spool type / Sürgü tipi
A	
B	
C	
D	
E	
F	
G	
H	
M	
N	
O	
P	
Q	
R	
S	
T	
L	

**Table / Tablo 4**

Code Kod	Spool control / Sürgü kontrolü
1	
2	
3	
4	
5	
6	
7	
8	
9	
10	
11	
12	
13	



**Table / Tablo 5**

Code / Kod	Incorporated microswitch / Mikroanahtar ile birleştirilmiş
E	 Microswitch type / Mikroanahtar tipi Omron - V 165 I C5

**Table / Tablo 6**

Code / Kod	Operation feature / Kontrol özelliği
P	 On-off pneumatic control / Açma-kapama pnömatik kontrol, 5-10 bar, ports NPTF 1/8-27
H	 On-off hydraulic control / Açma-kapama hidrolik kontrol, P <sub>n</sub> : 5-20 bar, ports G 1/4

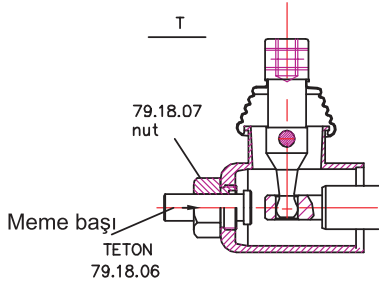

Table / Tablo 7

Code / Kod	Ports-Threads / Girişler – Diş tipleri				
	P	A, B	T	N	C2
<b>M</b>	M22x1.5	M122x1.5	M26x1.5	M26x1.5	M26x1.5
<b>G</b>	G 1/2	G 3/4	G 3/4	G 3/4	G 3/4
<b>S</b>	7/8-14UNF	7/8-14UNF	7/8-14UNF	1-1/16 -14UNF	1-1/16 -14UNF

Types of Hand Control / Elle kontrol tipleri

Table / Tablo 8

Code / Kod	Feature / Özellik	Code / Kod	Feature / Özellik	Code / Kod	Feature / Özellik
<b>KZ</b>		<b>KY</b>		<b>KI</b>	
<b>KZ1</b>		<b>KY1</b>		<b>KI1</b>	
<b>KZ0</b>		<b>KY0</b>		<b>KI0</b>	
<b>KZ01</b>		<b>KY01</b>		<b>KI01</b>	
-	Without hand control / Elle kontrolsüz				

Table / Tablo 9

Code / Kod		
<b>C</b>	Closed center / Kapalı merkez	
<b>C2</b>	Part for carry over / Carry over kısmı	
-	Without part for pressure carry over / Carry over kısmı olmadan	
<b>X</b>	Power beyond over to tank /	

Table / Tablo 10

Code / Kod	Used connection ports / Kullanılan bağlantı girişleri
<b>11</b>	P1, T1
<b>12</b>	P1, T2
<b>21</b>	P2, T1
<b>22</b>	P2, T2

..Z80 directional control valve – A

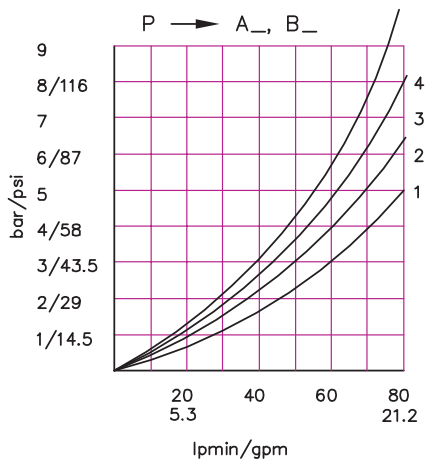
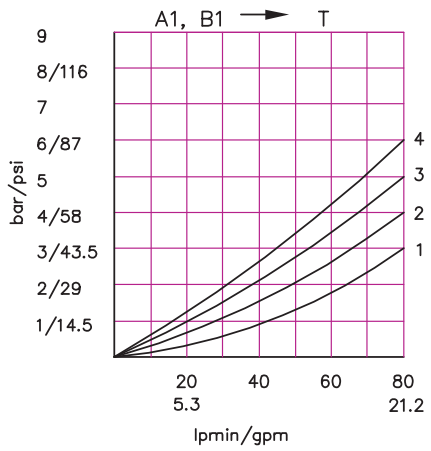
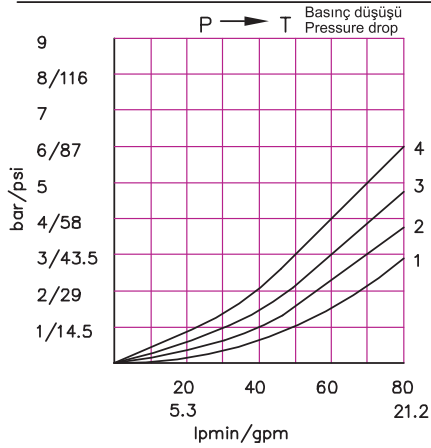

## REMOTE CONTROLS / UZAKTAN KONTROLLER

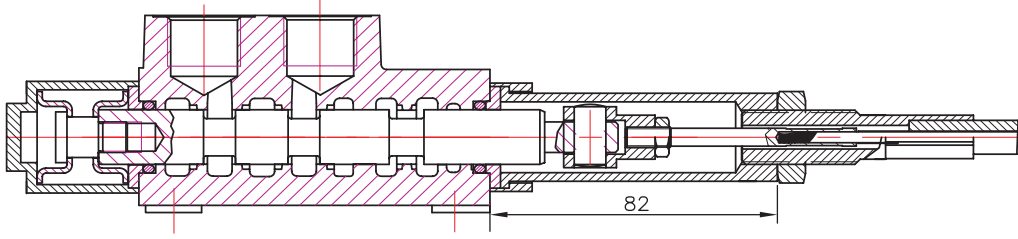

P80 A1G  
spool valve  
spul valfi  
(akış kontrol valfi)

V1(I= . . .)+  
cable  
kablo

3047  
control body  
kontrol gövdesi

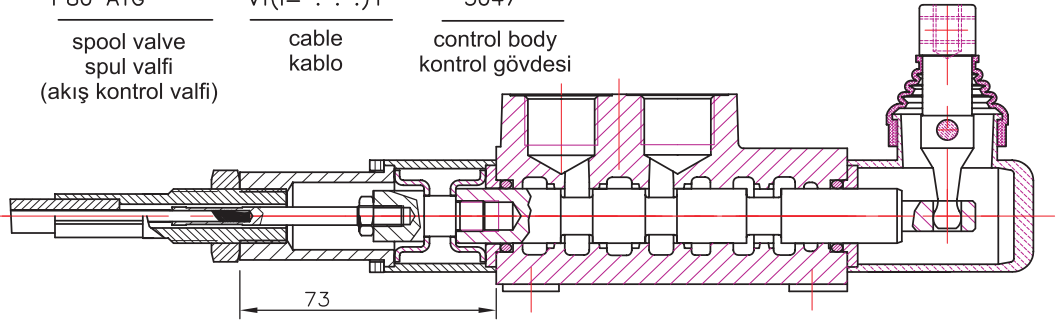

P80 A1G  
spool valve  
spul valfi  
(akış kontrol valfi)

V2KZ1(I= . . .)+  
cable  
kablo

3047  
control body  
kontrol gövdesi

Technical specifications / Teknik Özellikler			
	3047	3076	3077
Stroke / Strok	13+13 mm	13+13 mm	13+13 mm
Max. load / Mak. yükleme	45 kg	45 kg	45 kg
Level ratio / Düzey oranı	10:1	10:1	10:1
Lock in neutral/Serbest konumda kilitle	No	No	Yes
Antireverse lock / Emniyet kilidi	No	Yes	No
Body colour / Gövde rengi	Black	Black	Black
Cables type / Kablo tipi	Heavy Duty	Heavy Duty	Heavy Duty
Operating temperature / Kullanım Isısı	-40/+80C	-40/+80C	-40/+80C

High solidity controls for easy mounting on every type of distributor.  
They can be mounted stand alone or packed together.  
They use push-pull heavy duty cables that provide a positive smooth operating lever and are manufactured in three different models to meet different needs of Clients.  
Bütün kumanda kolları kolay monte edilir ve dayanıklı bir yapıya sahiptir. Montajlanmış veya demonte olarak gönderilebilir. Yüksek kalitede uzatma kabloları ile müşterilerin ihtiyaçları doğrultusunda uzaktan yönlendirme olanağı sağlar.

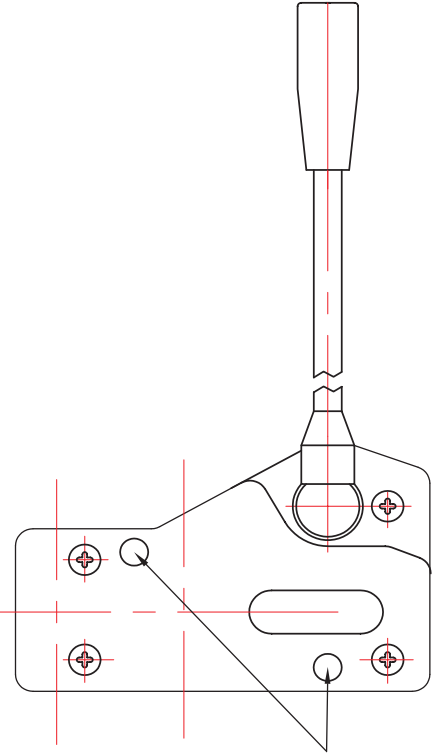

2 holes to mounting  
stackable  
birleştirme delikleri

### JOYSTICK "++"

his control gives the possibility to operate, at the same time two spool with a "++" movement

Bu kontrol sistemi aynı zamanda 2 tane sürgüyü kontrol edebilmemizi sağlar.

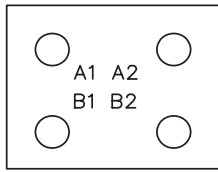
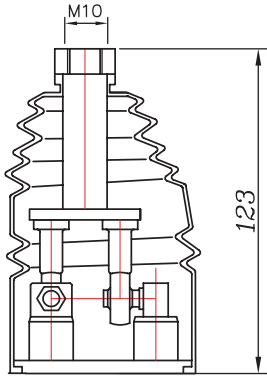

standart versiyon 1  
standard version 1

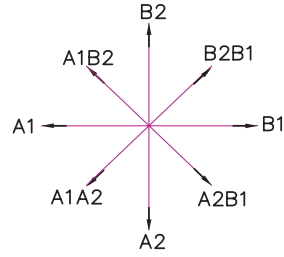
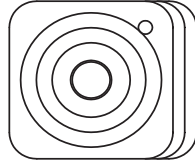

standart versiyon 2  
standard version 2

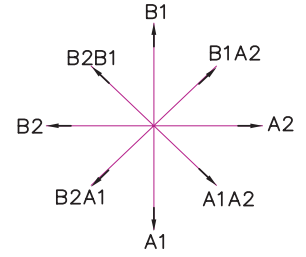
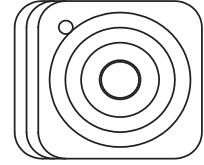

standart versiyon 3  
standard version 3

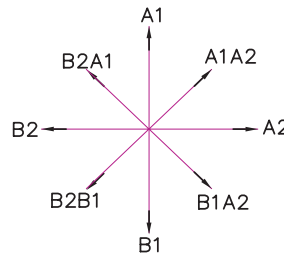
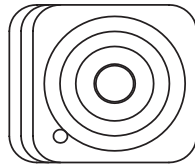

standart versiyon 4  
standard version 4

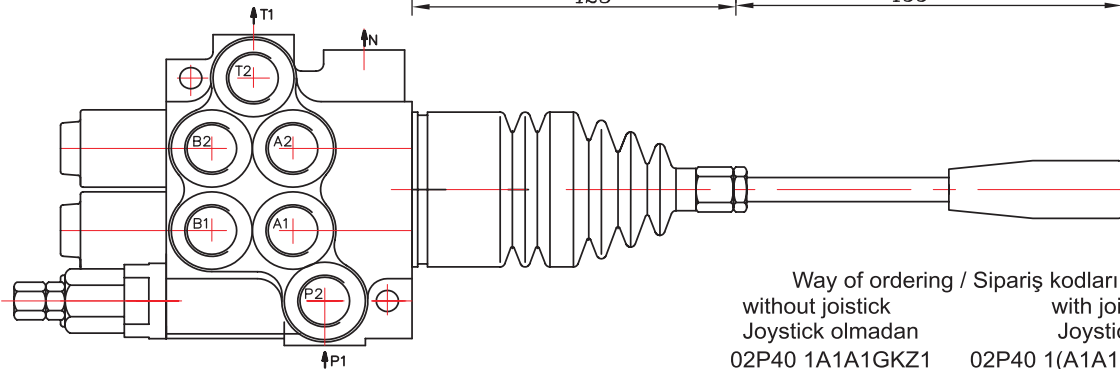
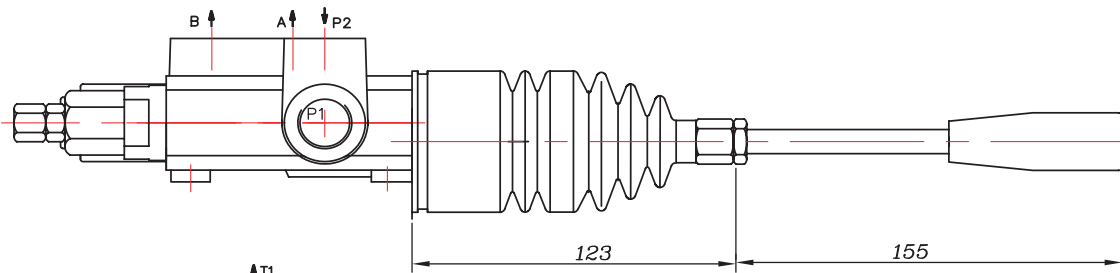
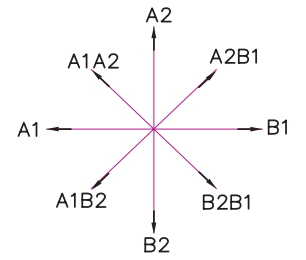
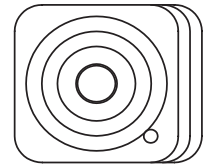

Way of ordering / Sipariş kodları  
without joystick / Joystick olmadan: 02P40 1A1A1GKZ1  
with joystick / Joystick ile: 02P40 1(A1A1)(js+3)G